

BRACKET B42

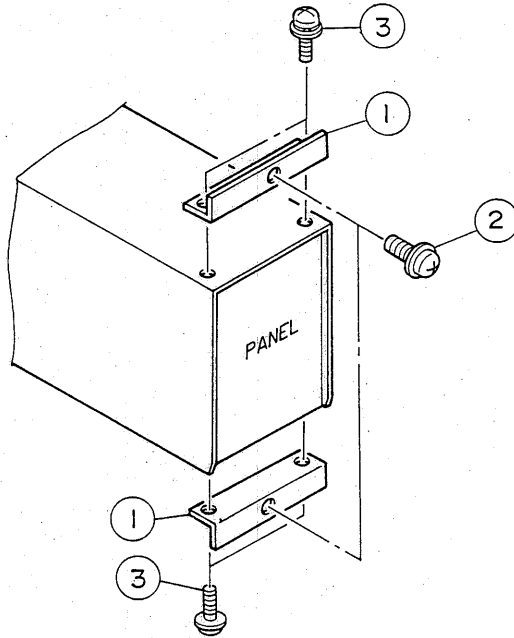

NO.	DESCRIPTION	QTY
1	BRACKET B42	2
2	SCREW WITH PW (S) M4x8 B-NI	2
3	SCREW WITH SW, PW M3x6 S-ZN	4